

**This electronic collection of documents is provided
for the convenience of the user
and is Not a Certified Document –**

**The documents contained herein were originally issued
and sealed by the individuals whose names and license
numbers appear on each page, on the dates appearing
with their signature on that page.**

**This file or an individual page
shall not be considered a certified document.**

COMPUTED BY: KTB DATE: 12-9-16
 CHECKED BY: DATE:

PROJECT REFERENCE NO. 14SP-202011	SHEET NO. X-1A
	
7/20/2018 10:37:24 AM PDT	
DOCUMENT NOT CONSIDERED FINAL UNLESS ALL SIGNATURES COMPLETED	

DIVISION OF HIGHWAYS
 STATE OF NORTH CAROLINA

CROSS SECTION SUMMARY

IN CUBIC YARDS

NOTE: EMBANKMENT COLUMN DOES NOT INCLUDE BACKFILL FOR UNDERCUT.

-L- LOCATION	UNCLASSIFIED EXCAVATION	EMBT
10+20	0	0
10+25	1	0
10+50	8	0
10+75	3	17
11+00	0	39
11+25	0	47
11+50	0	38
11+75	0	48
12+00	0	67
12+25	0	44
12+50	16	32
12+75	63	39
13+00	48	30
13+25	0	10

NOTE: EMBANKMENT COLUMN DOES NOT INCLUDE BACKFILL FOR UNDERCUT.

NOTE: Earthwork quantities are calculated by the Roadway Design Unit. These earthwork quantities are based in part on subsurface data provided by the Geotechnical Engineering Unit.

Approximate quantities only. Unclassified excavation, fine grading, clearing and grubbing, and removal of existing pavement will be paid for at the contract lump sum price for "grading".

-NEWDETOUR- LOCATION	UNCLASSIFIED EXCAVATION	EMBT
10+80	0	0
10+90	15	0
11+00	15	0
11+10	17	0
11+20	19	0
11+30	21	0
11+40	18	0
11+50	12	0
11+60	7	0
11+70	3	0
11+80	2	1
12+00	1	2
12+10	0	3
12+20	0	7
12+30	0	11
12+40	0	17
12+50	0	29
12+60	0	43
12+70	0	46
12+80	0	44
12+90	0	44
13+00	0	40
13+10	0	34
13+20	0	15

-NEWDETOUR-REMOVAL LOCATION	UNCLASSIFIED EXCAVATION	EMBT
-L- STA. 12+25	0	0
-L- STA. 12+50	58	0
-L- STA. 12+75	97	0
-L- STA. 13+00	88	0

NOTE: EMBANKMENT COLUMN DOES NOT INCLUDE BACKFILL FOR UNDERCUT.

8/23/99

0 2.5 5	PROJ. REFERENCE NO.	SHEET NO.
	14SP.20201.1	X-1

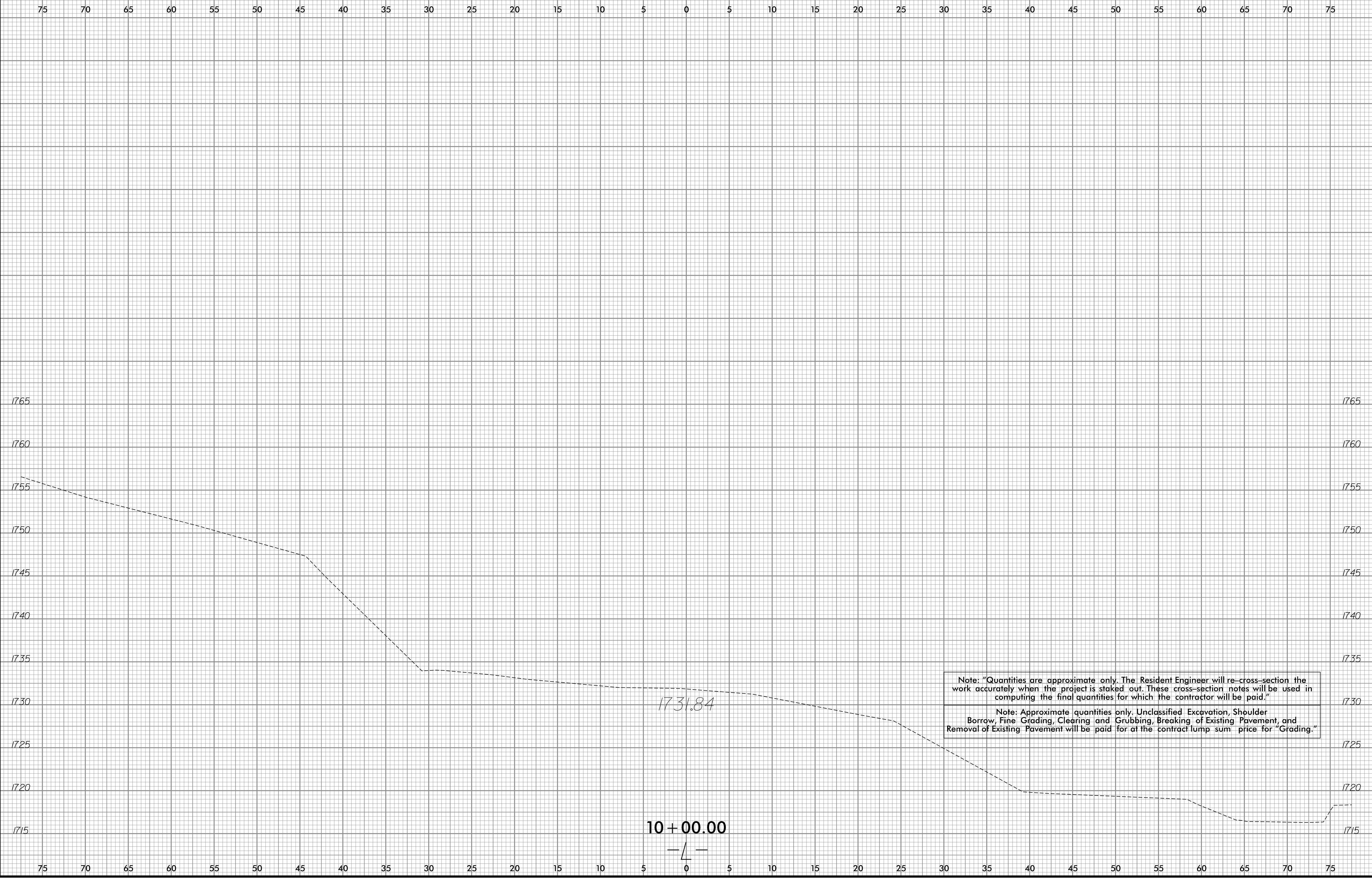

Note: "Quantities are approximate only. The Resident Engineer will re-cross-section the work accurately when the project is staked out. These cross-section notes will be used in computing the final quantities for which the contractor will be paid."

Note: Approximate quantities only. Unclassified Excavation, Shoulder Borrow, Fine Grading, Clearing and Grubbing, Breaking of Existing Pavement, and Removal of Existing Pavement will be paid for at the contract lump sum price for "Grading."

10 + 00.00
— L —

4/26/2017
S:\transportation\31236-11 MTC 14SP.20201.1 Cherokee 163\Roadway\Xsc\Cherokee 163.rdy.L_xpl.dgn
User:ldaves

8/23/99

0 2.5 5	PROJ. REFERENCE NO. 14SP.20201.1	SHEET NO. X-2
---------	-------------------------------------	------------------

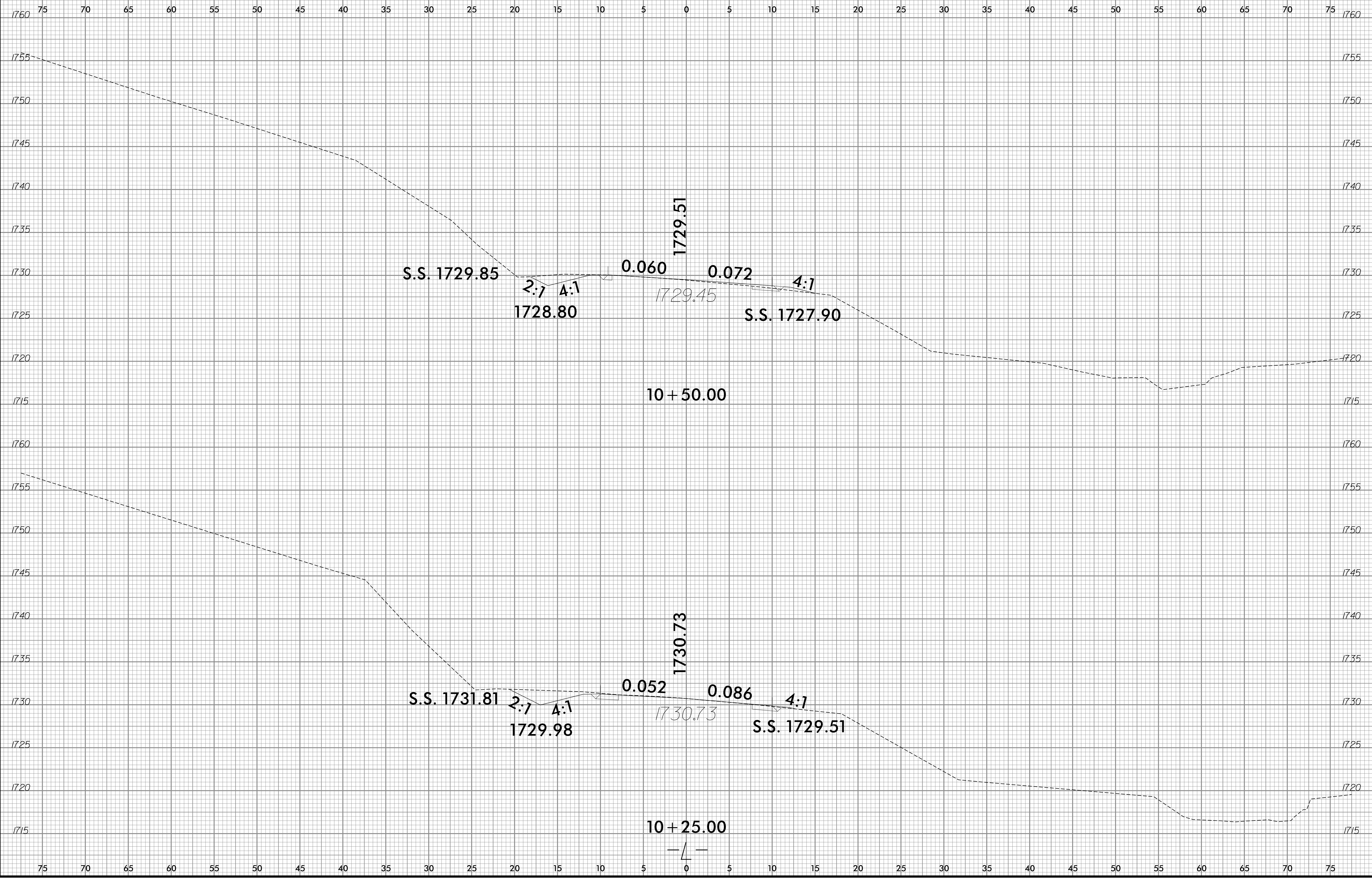

4/26/2017
S:\transportation\31236-11 MTC 14SP.20201.1 Cherokee 163\Roadway\Xsc\Cherokee 163.rdy.L_xpl.dgn
User:ldaves

8/23/99

0 2.5 5	PROJ. REFERENCE NO. 14SP.20201.1	SHEET NO. X-3
---------	-------------------------------------	------------------

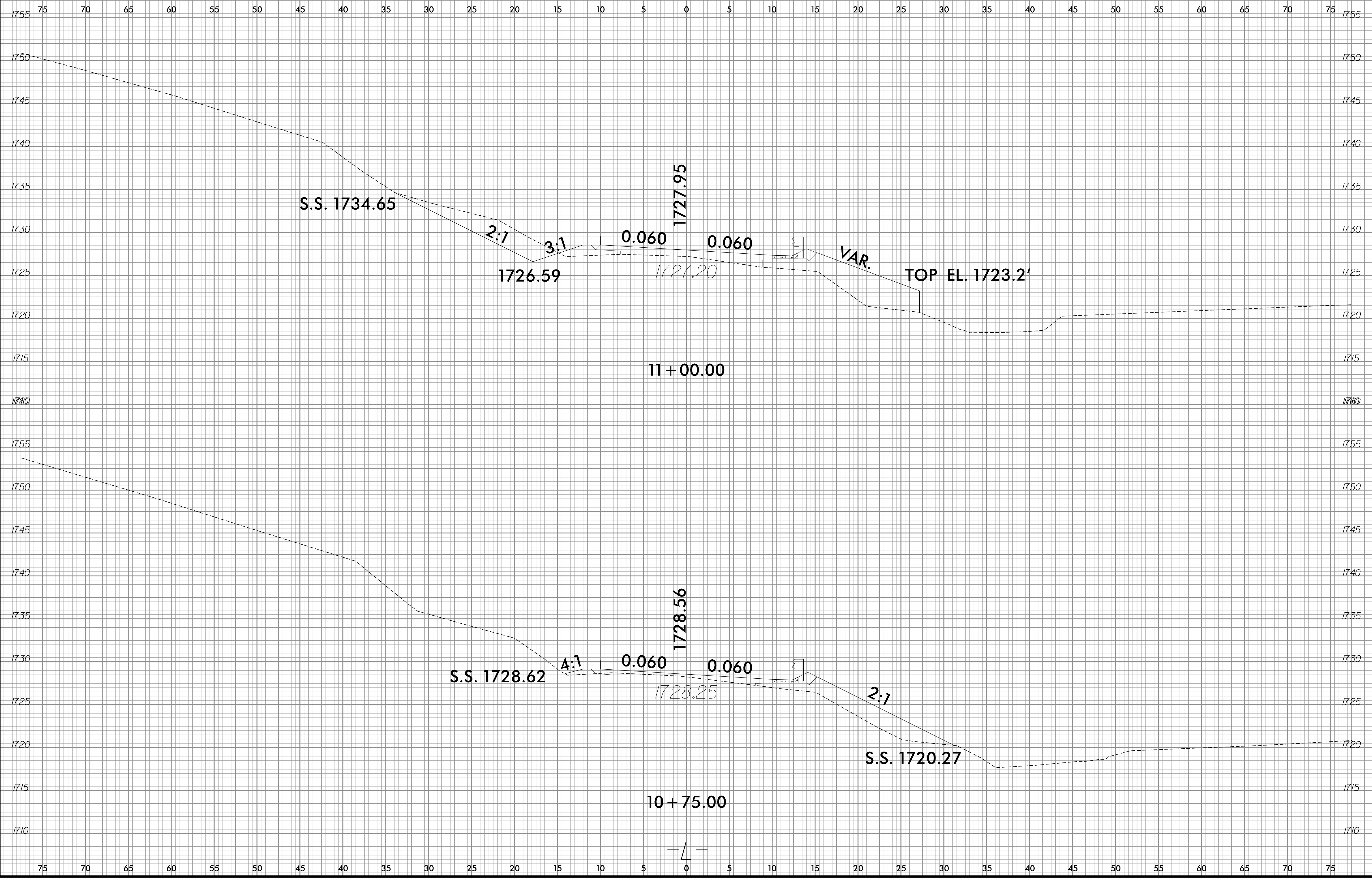

4/26/2017 5:17:00 PM S:\transportation\31236-11 MTC 14SP.20201.1 Cherokee 163\Roadway\Xsc\Cherokee 163.rdy.L_xpl.dgn User:ldaves

8/23/99

0 2.5 5	PROJ. REFERENCE NO. 14SP.20201.1	SHEET NO. X-4
---------	-------------------------------------	------------------

75 70 65 60 55 50 45 40 35 30 25 20 15 10 5 0 5 10 15 20 25 30 35 40 45 50 55 60 65 70 75

1745 1745

1740 1740

1735 1735

1730 1730

1725 1725

1720 1720

1715 1715

1745 1745

1740 1740

1735 1735

1730 1730

1725 1725

1720 1720

1715 1715

1745 1745

1740 1740

1735 1735

1730 1730

1725 1725

1720 1720

1715 1715

75 70 65 60 55 50 45 40 35 30 25 20 15 10 5 0 5 10 15 20 25 30 35 40 45 50 55 60 65 70 75

4/26/2017
S:\transportation\31236-11 MTC 14SP.20201.1 Cherokee 163\Roadway\Xsc\Cherokee 163.rdy.L_xpl.dgn
User:ldaves

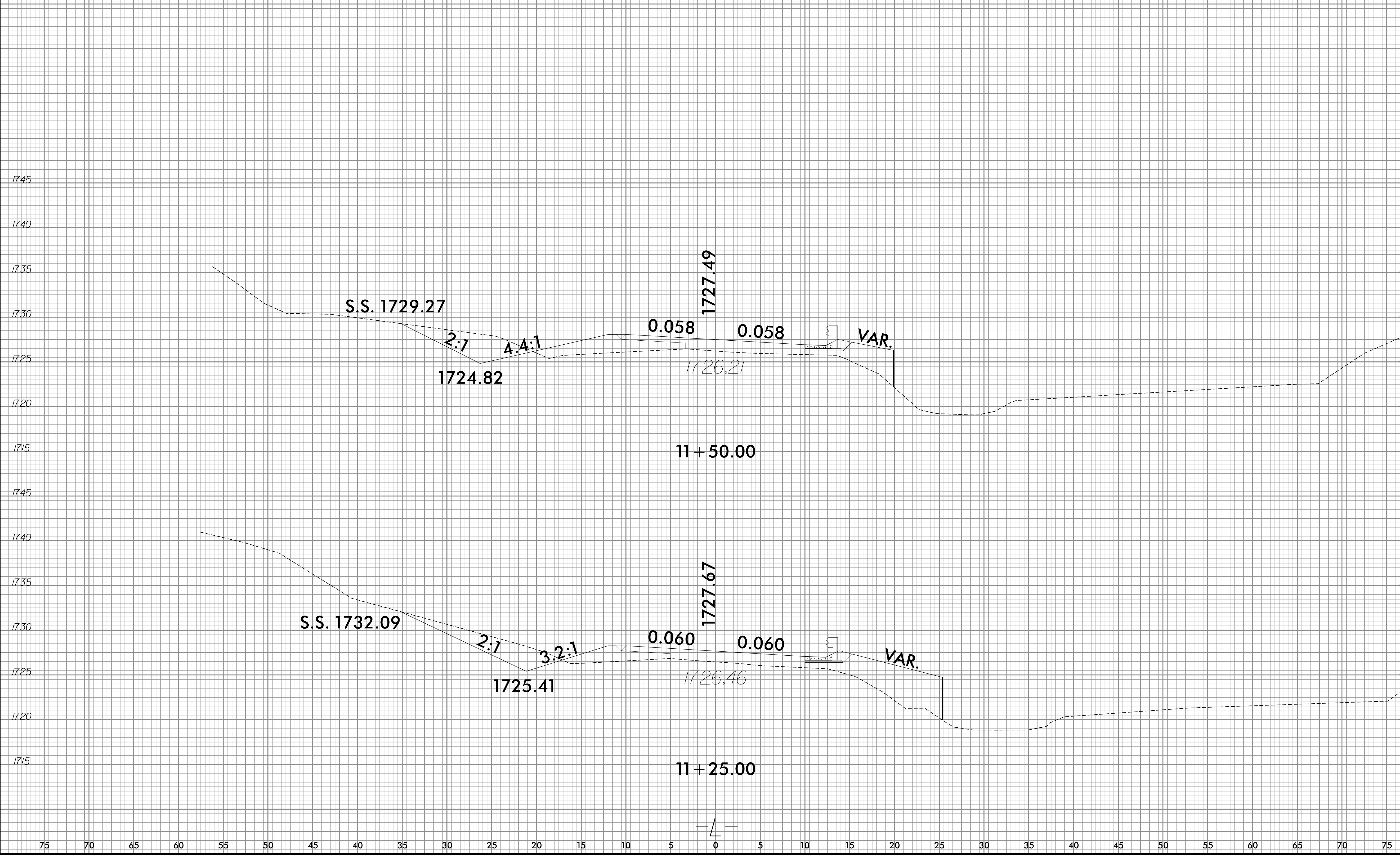

8/23/99
4/26/2017
S:\transportation\31236-11 MTC 14SP.20201.1 Cherokee 163\Roadway\Xsc\Cherokee 163.rdy.L_xpl.dgn
User:ldaves

0 2.5 5	PROJ. REFERENCE NO. 14SP.20201.1	SHEET NO. X-5
---------	-------------------------------------	------------------

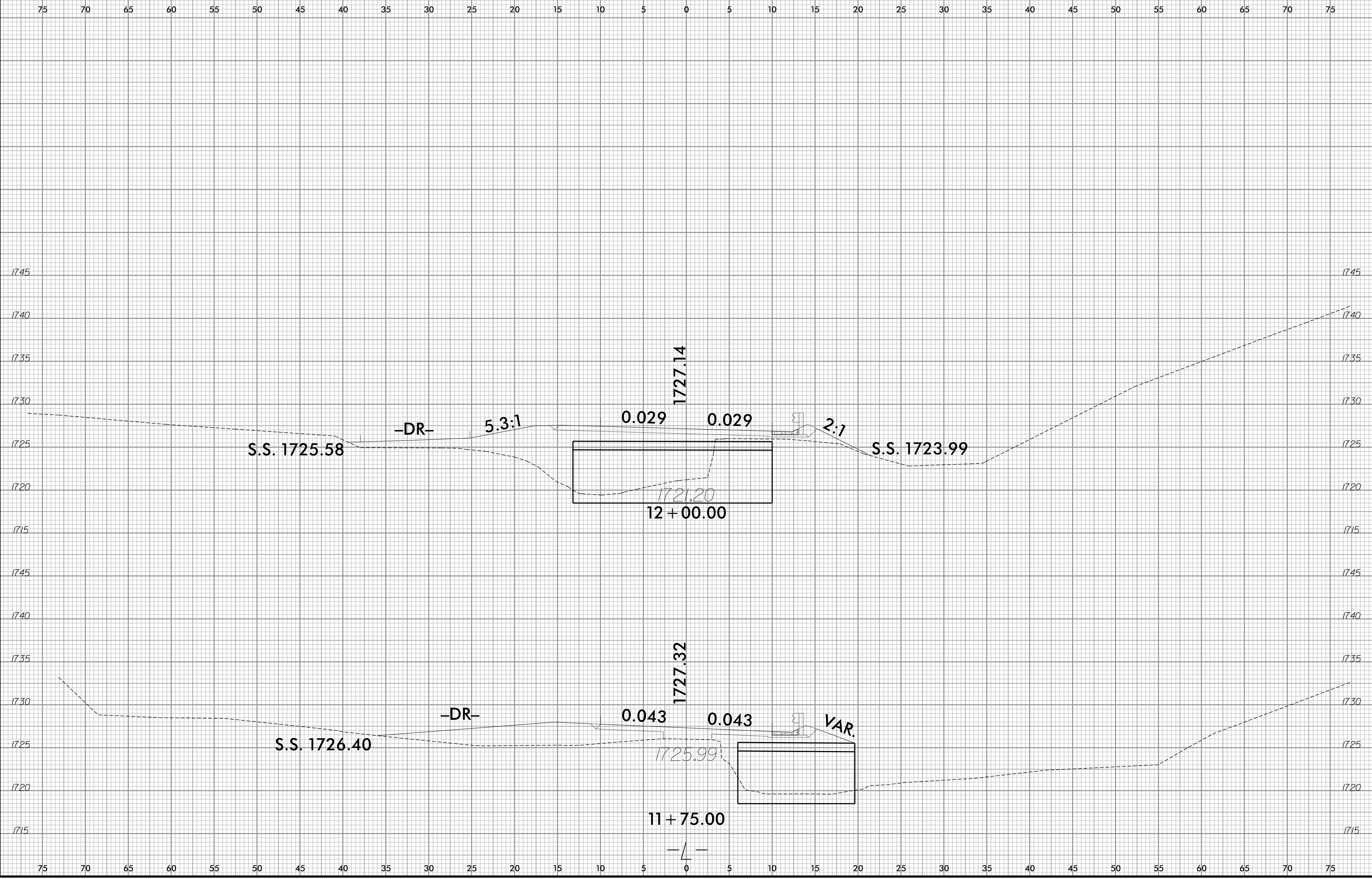

8/23/19

0 2.5 5	PROJ. REFERENCE NO.	SHEET NO.
	14SP.20201.1	X-6

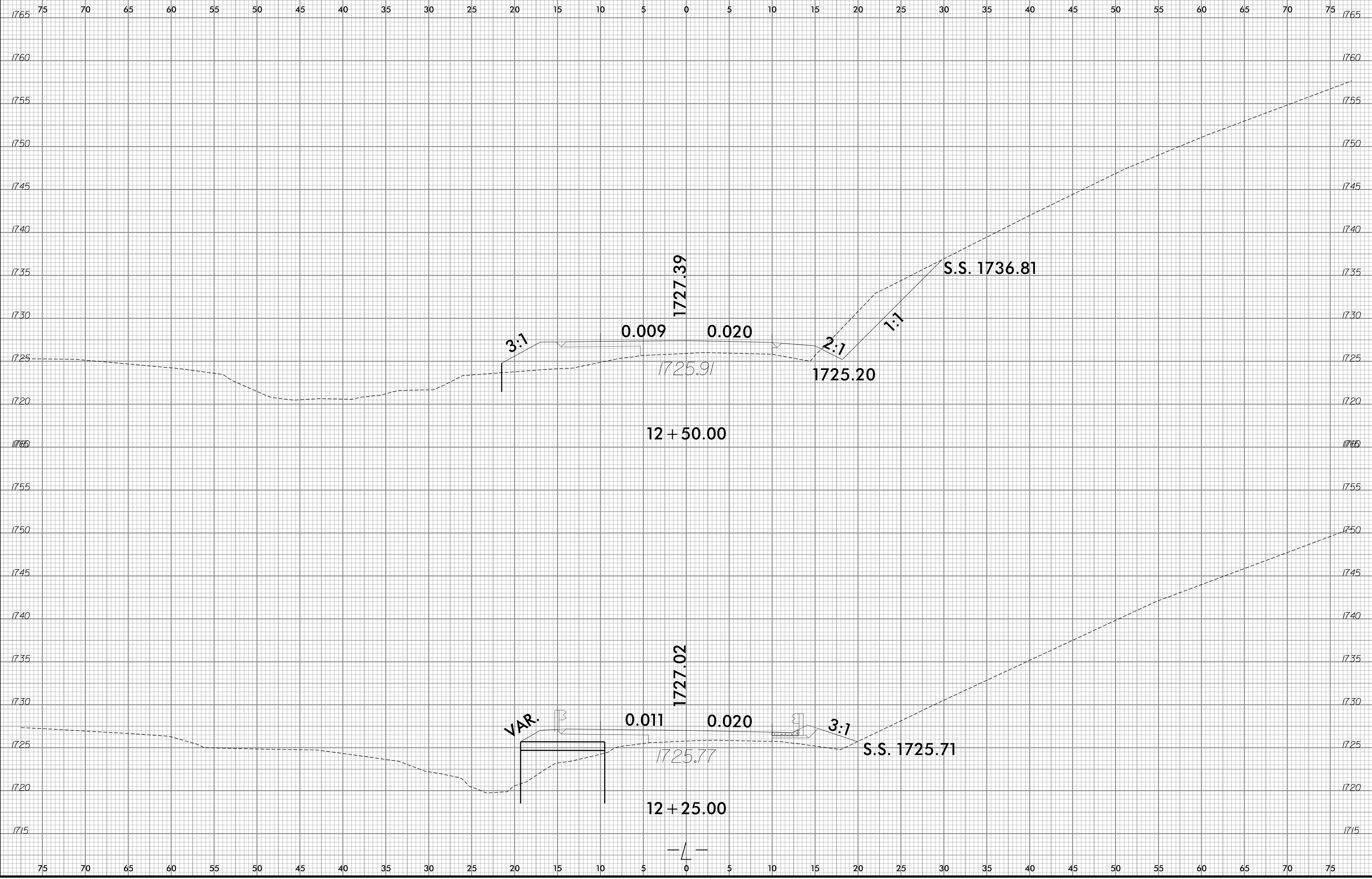

4/26/2017 5:17:00 PM S:\transportation\31236-11 MTC 14SP.20201.1 Cherokee 163\Roadway\Xsc\Cherokee 163.rdy.L_xpl.dgn User:ldaves

8/23/19
4/26/2017
S:\transportation\31236-11 MTC 14SP.20201.1 Cherokee 163\Roadway\Xsc\Cherokee 163.rdy.L_xpl.dgn
User:ldaves

0 2.5 5	PROJ. REFERENCE NO. 14SP.20201.1	SHEET NO. X-7
---------	-------------------------------------	------------------

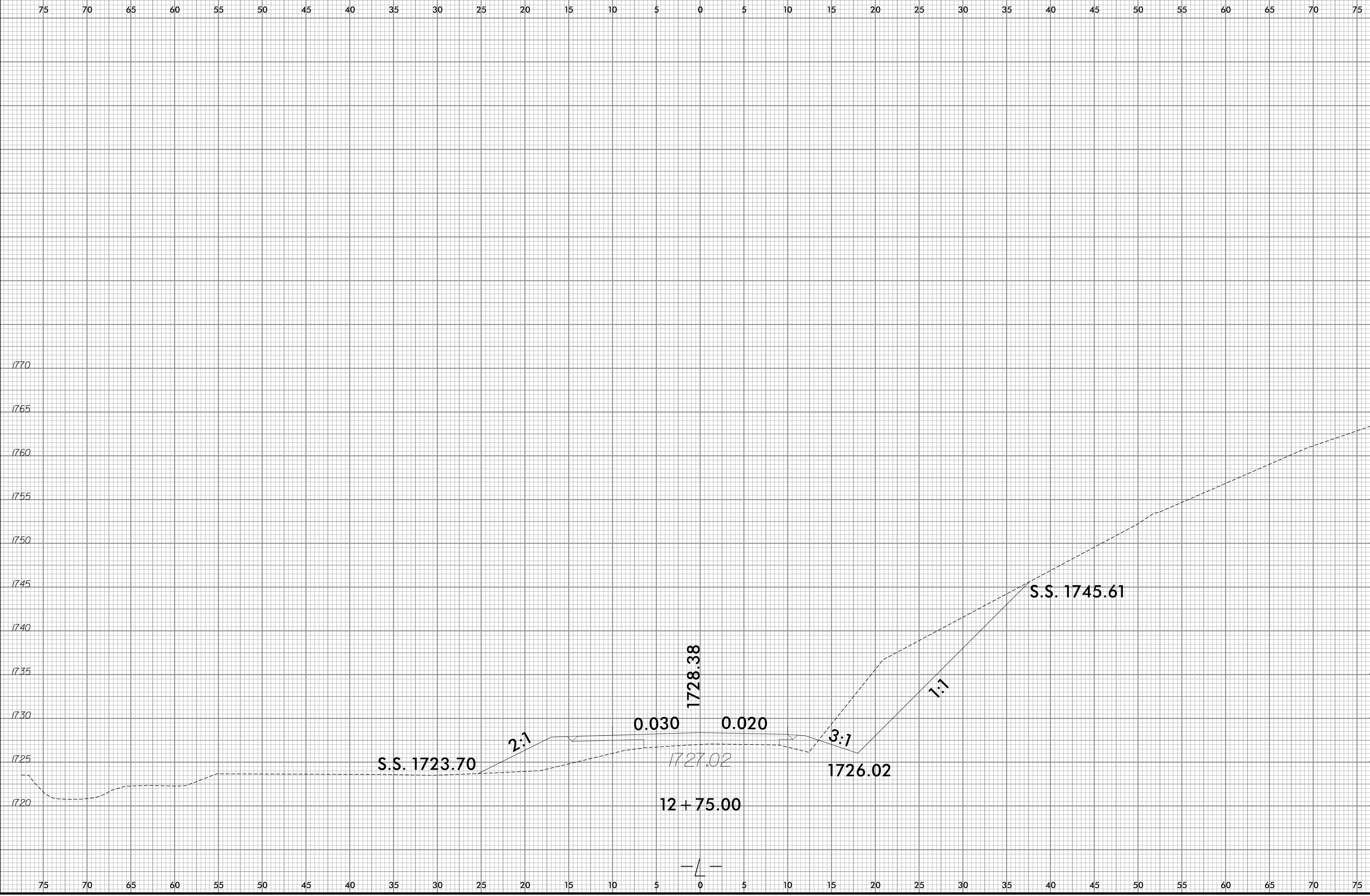

8/23/99

0 2.5 5	PROJ. REFERENCE NO. 14SP.20201.1	SHEET NO. X-8
---------	-------------------------------------	------------------

75 70 65 60 55 50 45 40 35 30 25 20 15 10 5 0 5 10 15 20 25 30 35 40 45 50 55 60 65 70 75

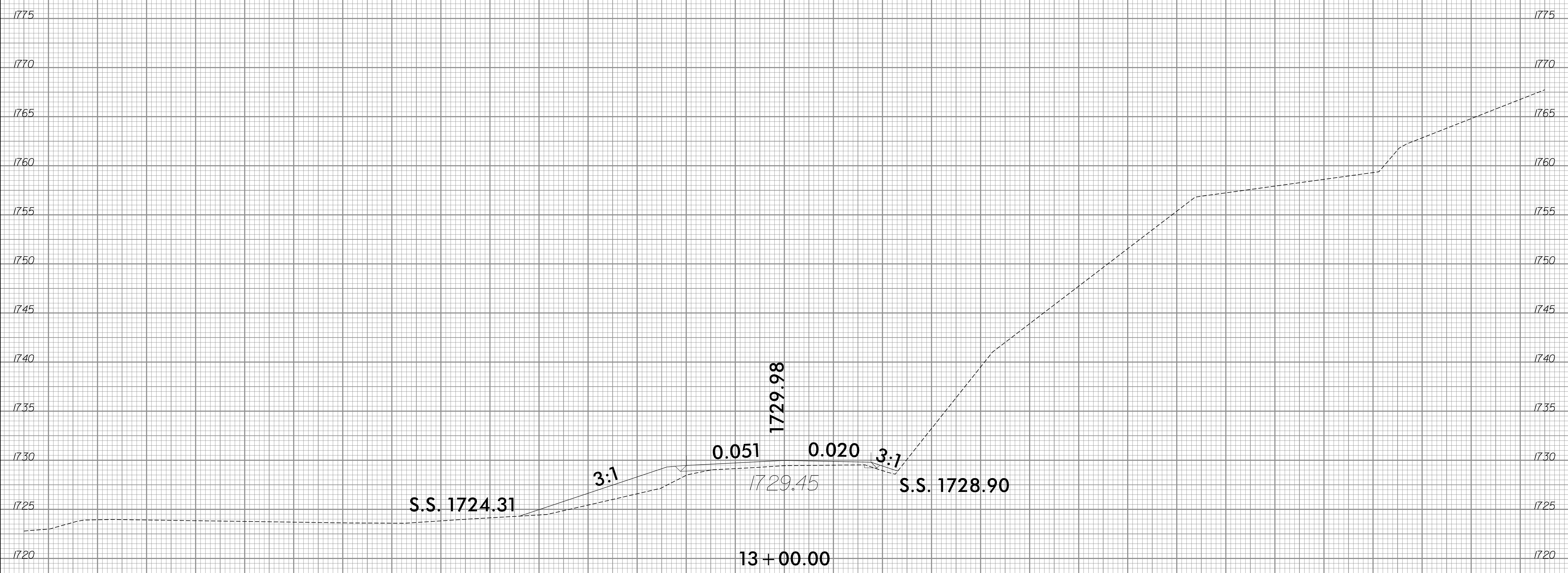

4/26/2017
S:\transportation\31236-11 MTC 14SP.20201.1 Cherokee 163\Roadway\Xsc\Cherokee 163.rdy.L_xpl.dgn
User:ldaves

75 70 65 60 55 50 45 40 35 30 25 20 15 10 5 0 5 10 15 20 25 30 35 40 45 50 55 60 65 70 75

8/23/99

0 2.5 5	PROJ. REFERENCE NO.	SHEET NO.
	14SP.20201.1	X-9

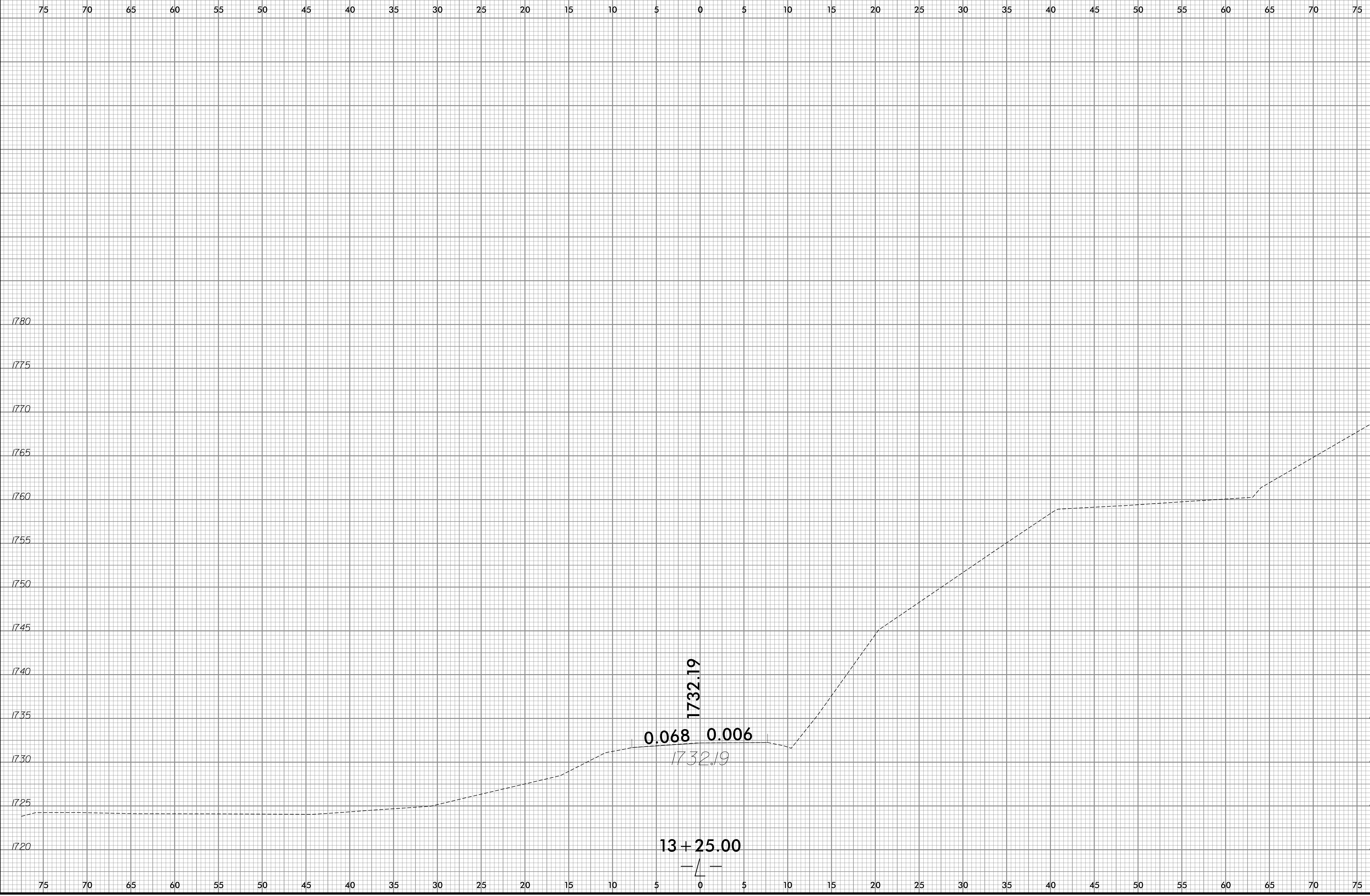

4/26/2017
S:\transportation\31236-11 MTC 14SP.20201.1 Cherokee 163\Roadway\Xsc\Cherokee 163.rdy.L_xpl.dgn
User:ldaves

8/23/19
4/26/2017
S:\transportation\31236-11 MTC 14SP.20201.1 Cherokee 163\Roadway\Xsc\Cherokee 163.rdy.L_xpl.dgn
User:ldaves

0 2.5 5	PROJ. REFERENCE NO. 14SP.20201.1	SHEET NO. X-10
---------	-------------------------------------	-------------------

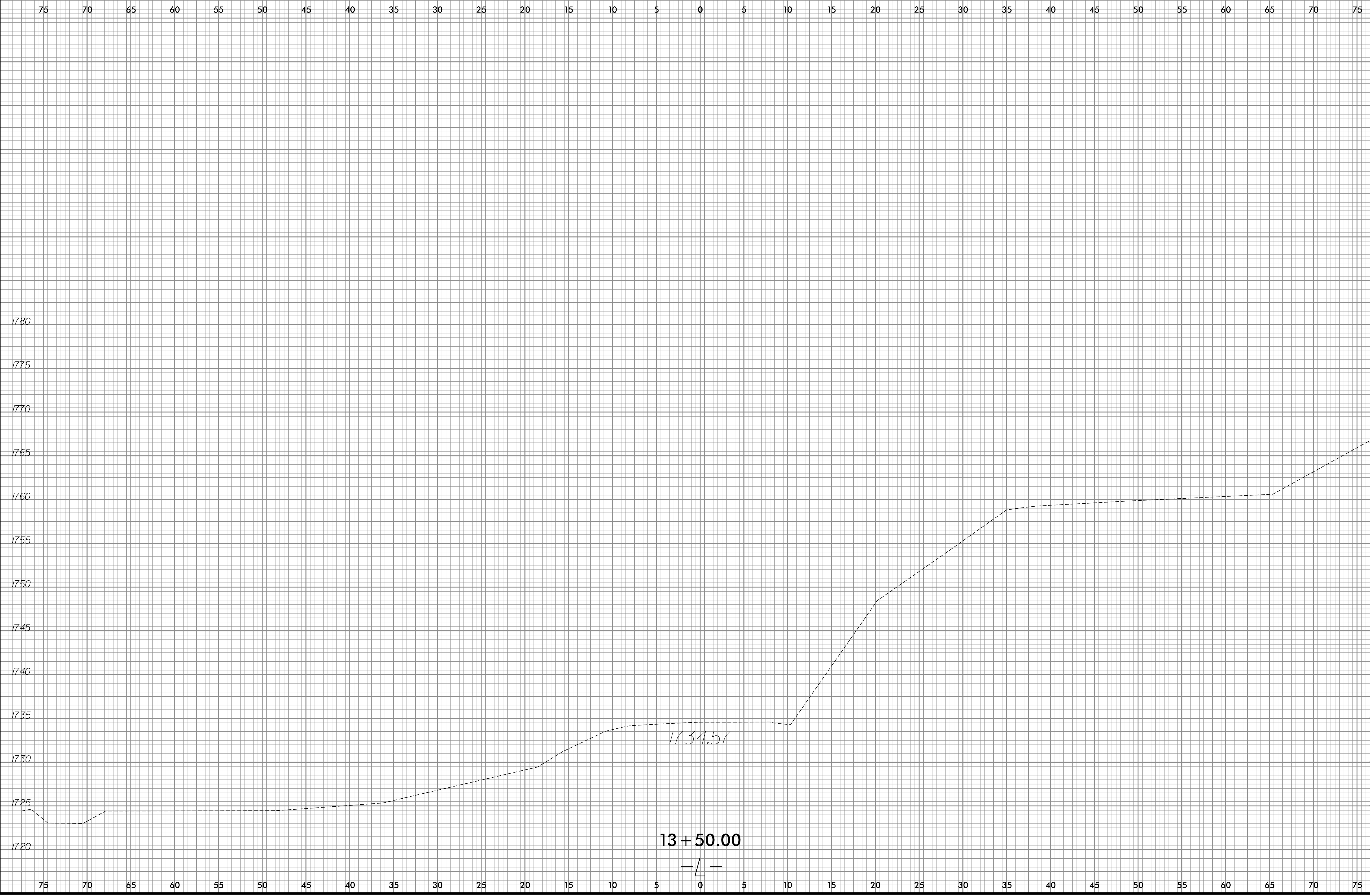

8/23/99

0 2.5 5	PROJ. REFERENCE NO.	SHEET NO.
	14SP.20201.1	X-11

75 70 65 60 55 50 45 40 35 30 25 20 15 10 5 0 5 10 15 20 25 30 35 40 45 50 55 60 65 70 75

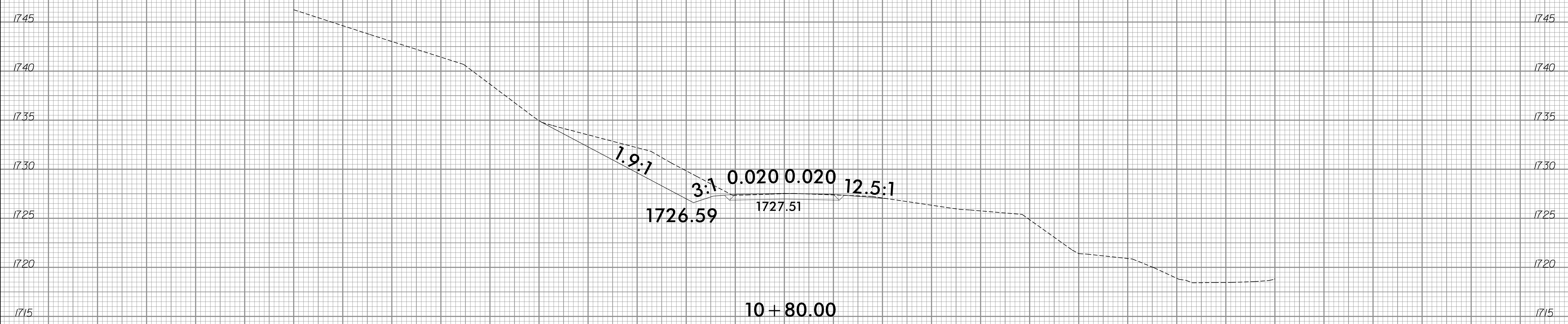

75 70 65 60 55 50 45 40 35 30 25 20 15 10 5 0 5 10 15 20 25 30 35 40 45 50 55 60 65 70 75

4/26/2017
 S:\transportation\31236-11 MTC 14SP.20201.1 Cherokee 163\Roadway\Xsc\Cherokee 163.rdy-Newdetour-pshx01-x06.dgn
 User:ldaves

8/23/99

0 2.5 5	PROJ. REFERENCE NO.	SHEET NO.
	14SP.20201.1	X-12

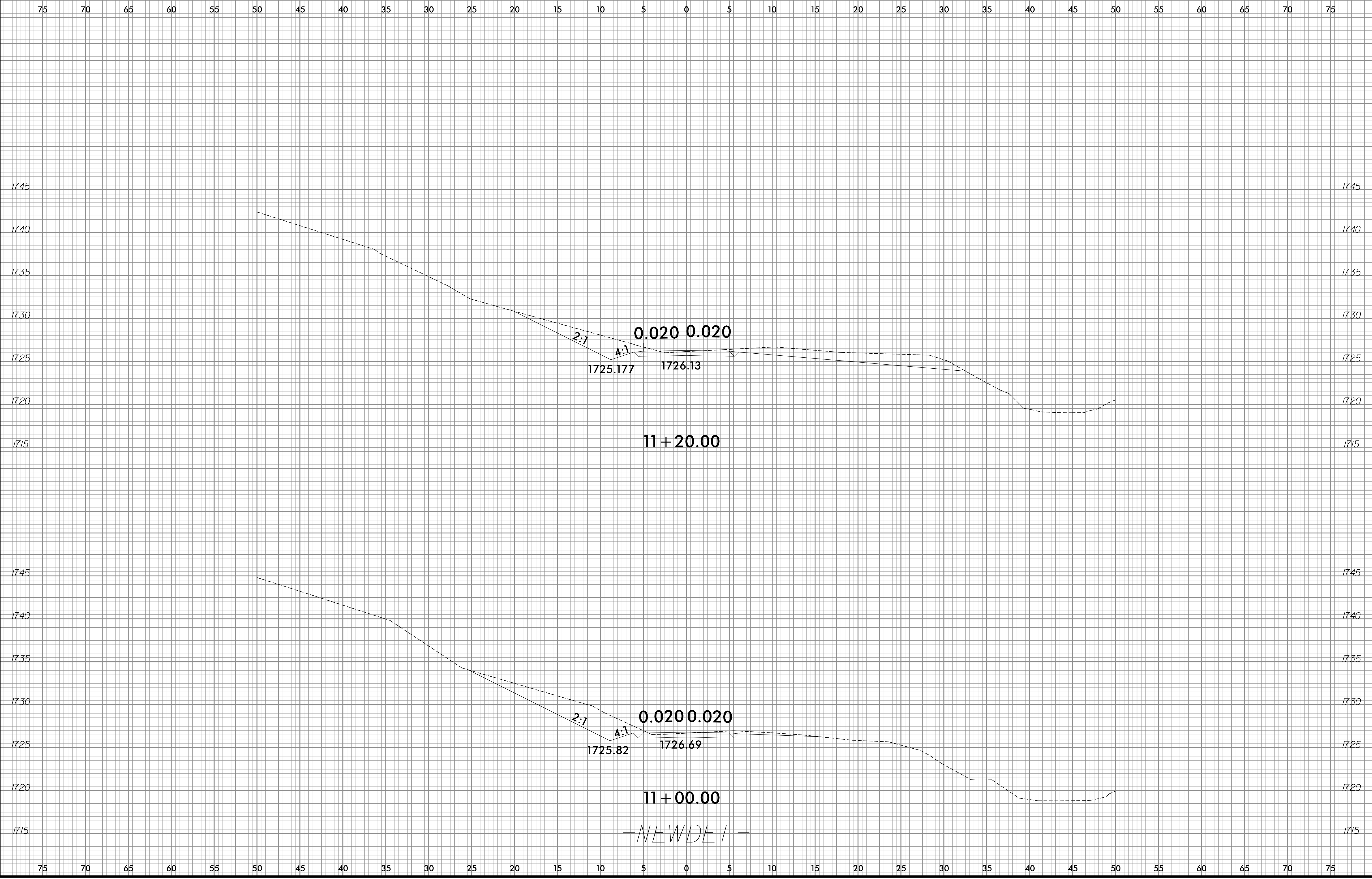

4/26/2017
S:\transportation\31236-11 MTC 14SP.20201.1 Cherokee 163\Roadway\Xsc\Cherokee 163.rdy-Newdetour-pslx01-x06.dgn
User:ldaves

—NEWDET—

8/23/99

0 2.5 5	PROJ. REFERENCE NO. 14SP.20201.1	SHEET NO. X-13
---------	-------------------------------------	-------------------

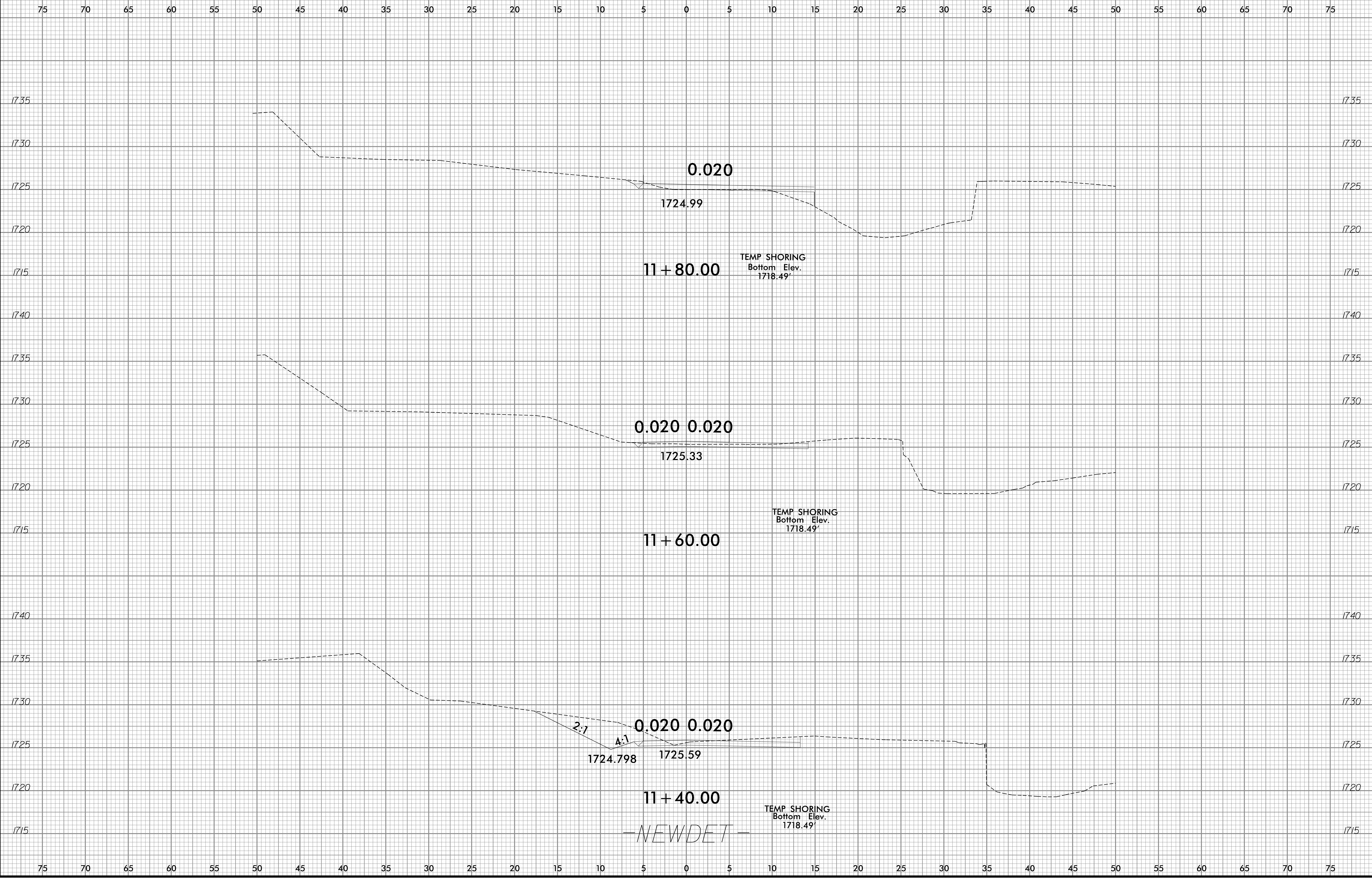

4/26/2017
S:\transportation\31236-11 MTC 14SP.20201.1 Cherokee 163\Roadway\Xsc\Cherokee 163.rdy-Newdetour-pshx01-x06.dgn
User:ldaves

8/23/19

0 2.5 5	PROJ. REFERENCE NO.	SHEET NO.
	14SP.20201.1	X-14

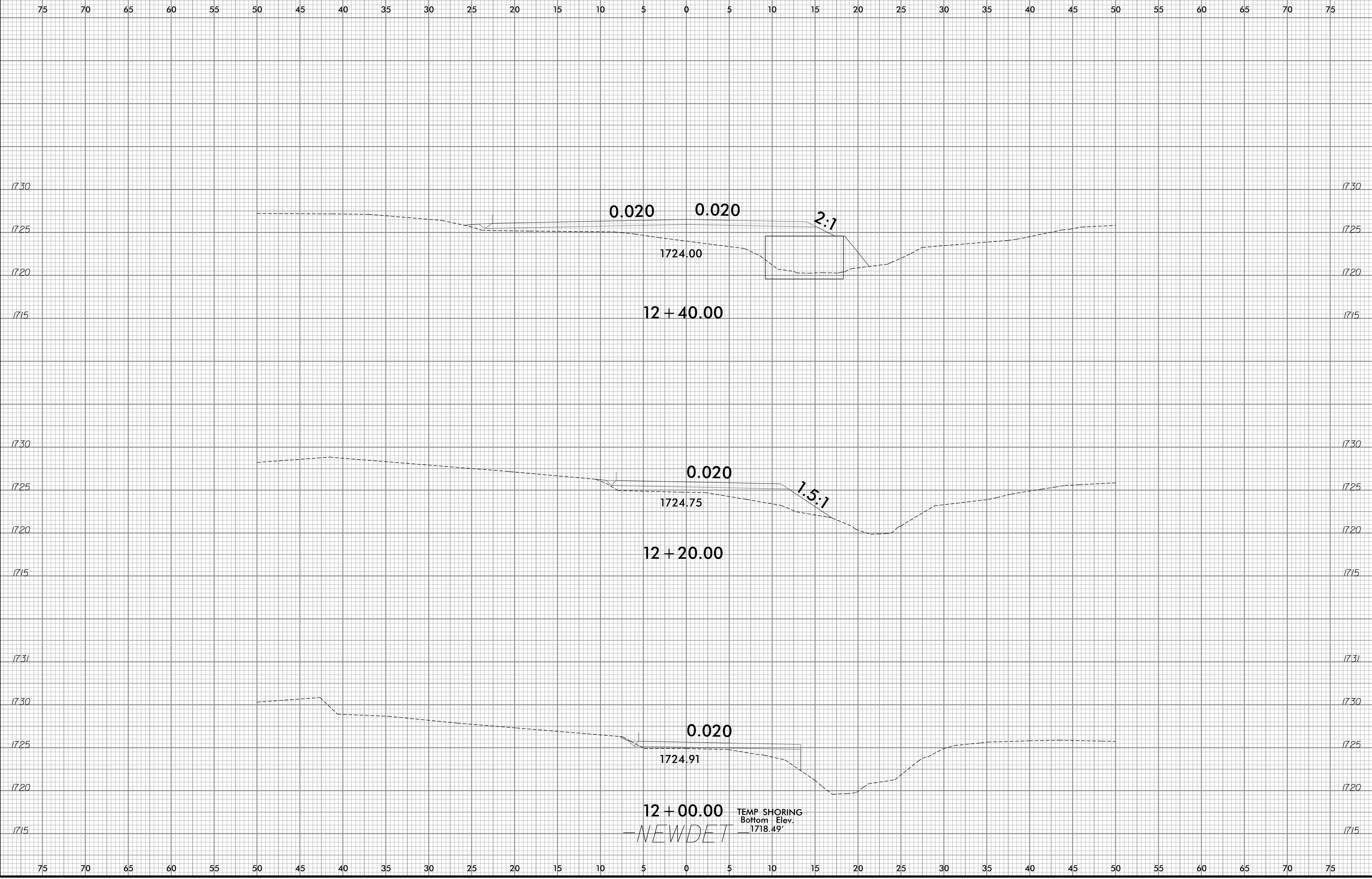

4/26/2017 S:\transportation\31236-11 MTC 14SP.20201.1 Cherokee 163\Roadway\Xsc\Cherokee 163.rdy-Newdetour-pshx01.x06.dgn User:ldaves

8/23/19

0 2.5 5	PROJ. REFERENCE NO.	SHEET NO.
	14SP.20201.1	X-15

75 70 65 60 55 50 45 40 35 30 25 20 15 10 5 0 5 10 15 20 25 30 35 40 45 50 55 60 65 70 75

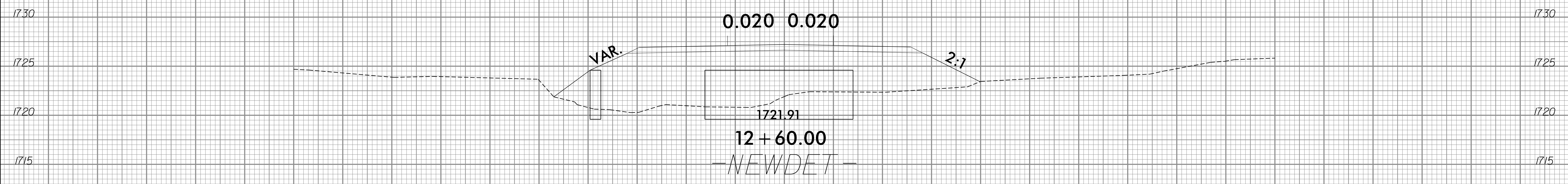
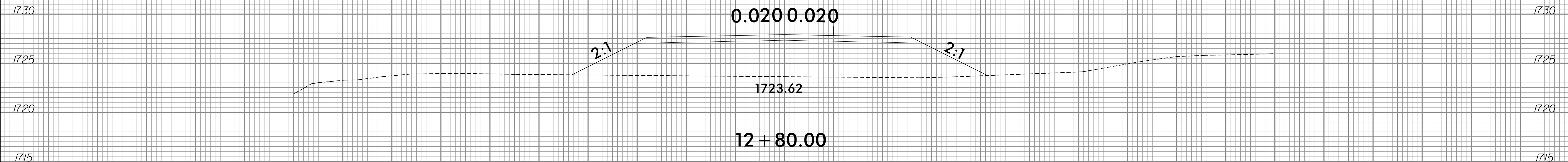
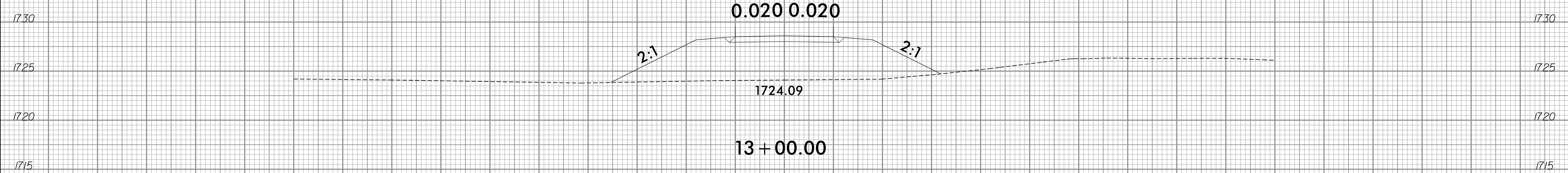

75 70 65 60 55 50 45 40 35 30 25 20 15 10 5 0 5 10 15 20 25 30 35 40 45 50 55 60 65 70 75

4/26/2017
S:\transportation\31236-11 MTC 14SP.20201.1 Cherokee 163\Roadway\Xsc\Cherokee 163.rdy-Newdetour-pslx01.x06.dgn
User:ldaves

8/23/99

0 2.5 5	PROJ. REFERENCE NO.	SHEET NO.
	14SP.20201.1	X-16

75 70 65 60 55 50 45 40 35 30 25 20 15 10 5 0 5 10 15 20 25 30 35 40 45 50 55 60 65 70 75

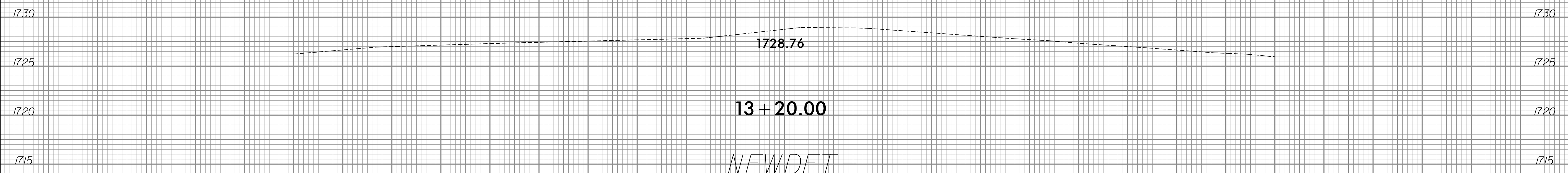

75 70 65 60 55 50 45 40 35 30 25 20 15 10 5 0 5 10 15 20 25 30 35 40 45 50 55 60 65 70 75

4/26/2017
 S:\transportation\31236-11 MTC 14SP.20201.1 Cherokee 163\Roadway\Xsc\Cherokee 163.rdy-Newdetour-pslx01-x06.dgn
 User:ldaves

6/23/16

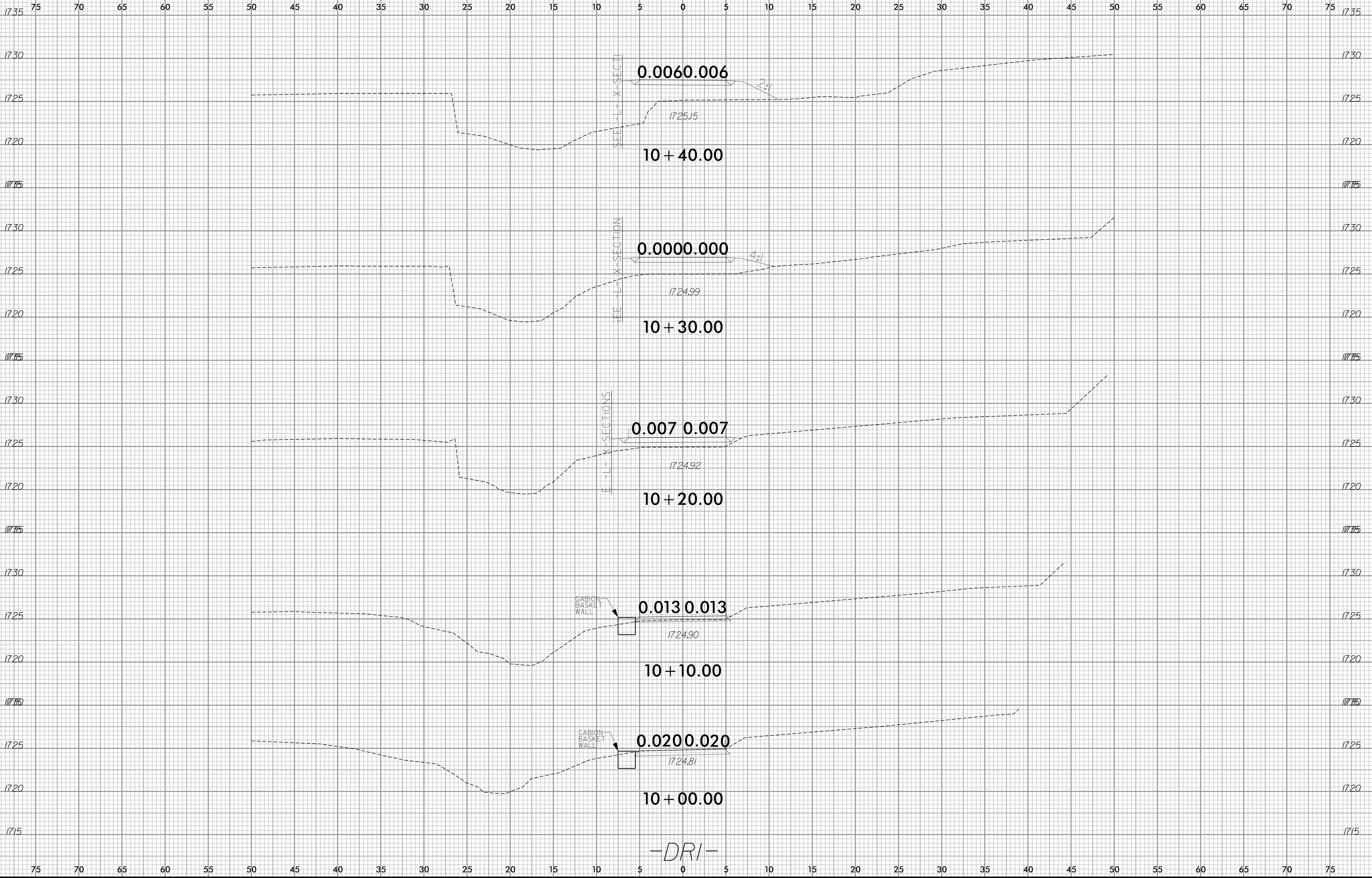

4/26/2017 S:\transportation\31236-11 MTC 14SP.20201.1 Cherokee 163\Roadway\Xsc\Cherokee 163_rdy_DRI_xpl.dgn

6/23/16

0 2.5 5	PROJ. REFERENCE NO. 14SP.20201.1	SHEET NO. X-18
---------	-------------------------------------	-------------------

75 70 65 60 55 50 45 40 35 30 25 20 15 10 5 0 5 10 15 20 25 30 35 40 45 50 55 60 65 70 75

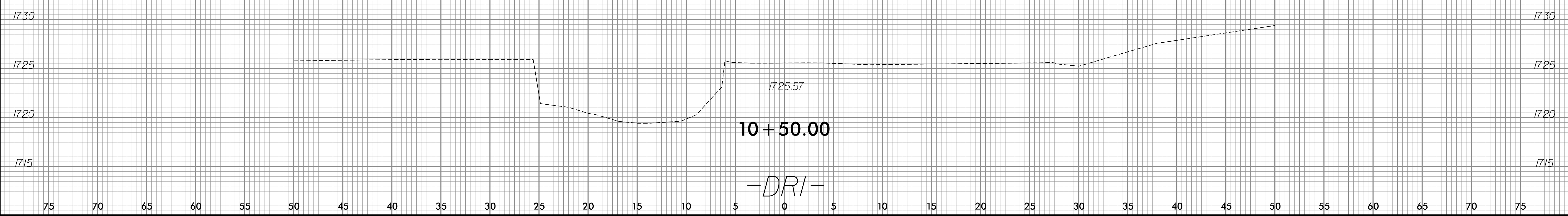

4/26/2017
S:\transportation\31236-11 MTC 14SP.20201.1 Cherokee 163\Roadway\Xsc\Cherokee 163_rdy_DRI_xpl.dgn
user:lddaves